

Unpacking

Before you begin using the device, please check the version you got and ensure that the following items are included in the shipped box:



NS-2 x 1



Power cable (with DC) x 1

Device Installation

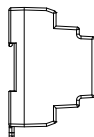
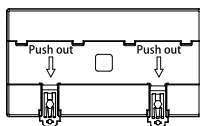
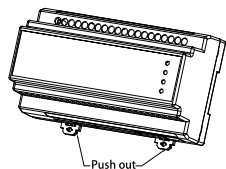

Push out the two clasps completely.

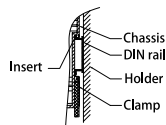
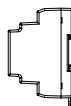
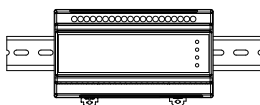
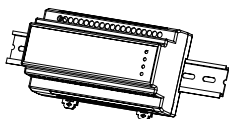

Description of partial section view

Insert the guide groove on the raised part of the bottom of the equipment shell into one side of the guide rail, and fit the NS-2 on the guide rail.

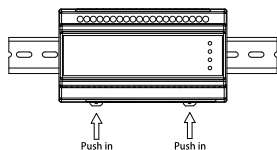
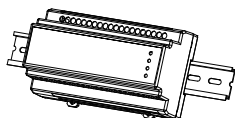

PRESS

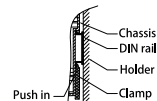

Description of partial section view

Press down the NS-2 on the front, push the two clasps upwards, and make the buckles snap into the guide rail, and then fix it on to the guide rail.

Power Adapter Installation

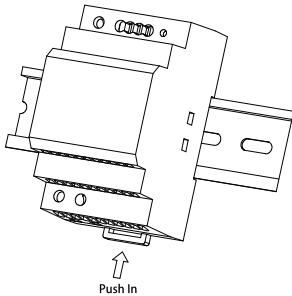

Place the power adapter on the corresponding position of the guide rail as shown in the figure above, and fasten the plastic buckle on the guide rail to fix the power adapter.

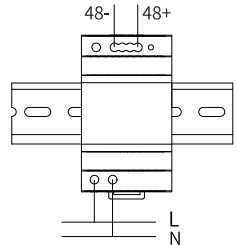
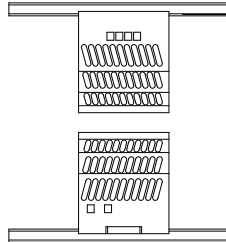

Note: The power adapter is 48V/1.25A DC or 24V/2A DC. Please refer to Device Wiring section for more connection details.

Note: Power adapter was not provided in the shipped box, please purchase it separately if you need it.

Device Wiring

Note:

- Each NS-2 supports a maximum of 6 loads, otherwise, it may not be powered on or power off during use.
- The PLC-S lead wire of NS-2 must be kept at least 5 cm away from the PLC-1~PLC-6 lead wire, otherwise the signal will loop back and the network cannot be used.

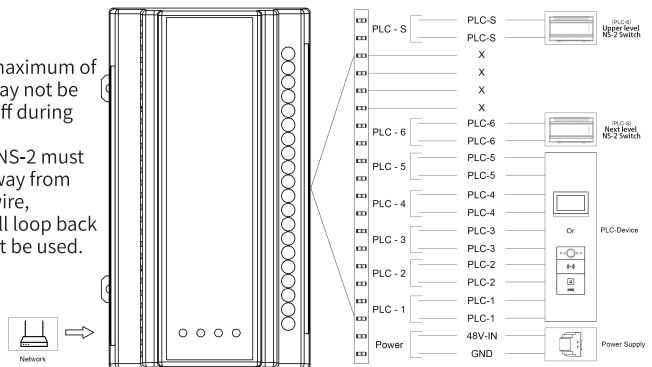

Application Network Topology

Topology-1: each device connect to NS-2 separately.

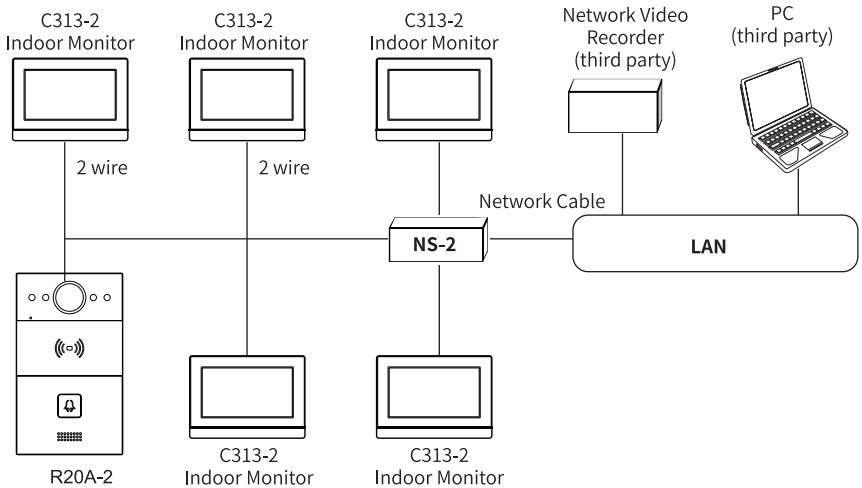

Adapter Voltage	Cable Model	Farthest Distance	Adapter Voltage	Cable Model	Farthest Distance
48V	24awg	300m	24V	24awg	150m
	20awg	300m		20awg	250m
	18awg	300m		18awg	300m

Topology-2: devices are series connection with NS-2.

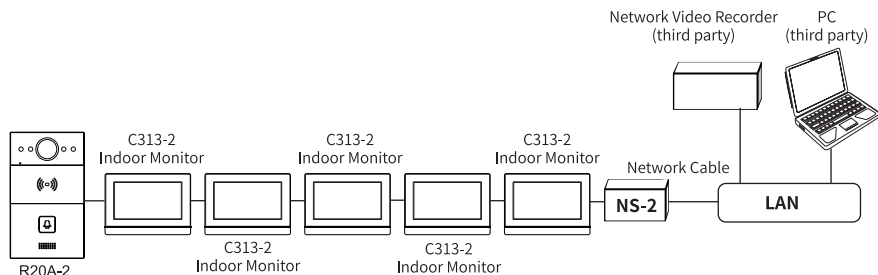

Adaptor Voltage	Cable Model	Farthest Distance	Adaptor Voltage	Cable Model	Farthest Distance
48V	24awg	100m/6devices 150m/4devices 200m/3devices	24V	24awg	50m/3devices 150m/1device
	20awg	250m/6devices 300m/5devices		20awg	100m/3devices 150m/2devices 250m/1device
	18awg	300m/6devices		18awg	100m/6devices 150m/4devices 200m/3devices 300m/2devices

Note: When using different cable, the maximum number of devices can connect to NS-2 under the different maximum distances which can refer to the above table. For example, when using a 24awg cable, if the farthest distance is 100m, the maximum number of devices connect to NS-2 is 6.

Notice Information

Information contained in this document is believed to be accurate and reliable at the time of printing. This document is subject to change without notice, any update to this document can be viewed on Akuvox' s website: <http://www.akuvox.com> © Copyright 2022 Akuvox Ltd. All rights reserved.



AKUVOX (XIAMEN) NETWORKS CO., LTD.

ADD: 10/F, NO.56 GUANRI ROAD, SOFTWARE PARK II, XIAMEN 361009, CHINA
www.akuvox.com



YS00000413