

Unpacking

Please make sure the package contains the following items:

Universal Accessories:

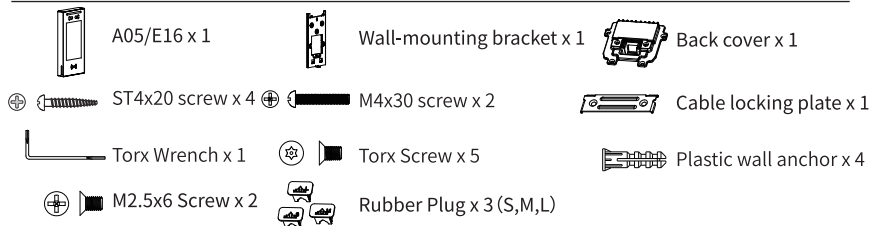

Digital Temperature Detector Accessories (Optional):

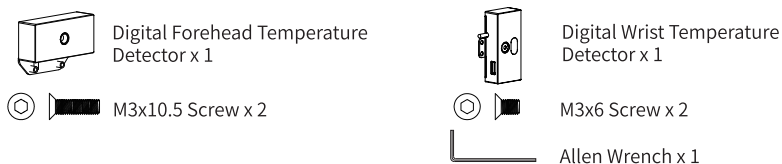

Product Overview

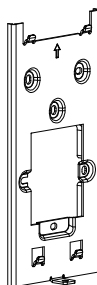
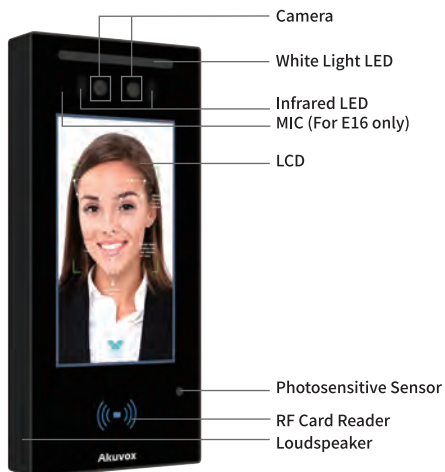

The bracket for the device with no temperature detector

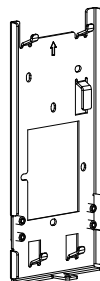

The bracket for the device with temperature detector

Installation

1. Step1: Wall-mounting Bracket Installation

1.1 With embedded one-gang junction box (86x86 mm or 2x3 inches in size) in the wall

1.1.1 With 86x86 mm embedded junction box in the wall

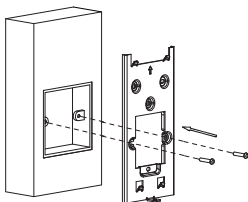

Fix the wall-mounting bracket on the embedded box with two M4x30 screws.

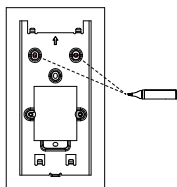

Mark the two positioning holes of the wall-mounting bracket on the wall.

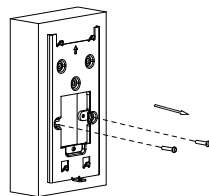

Remove the two M4x30 screws and take off the wall-mounting bracket.

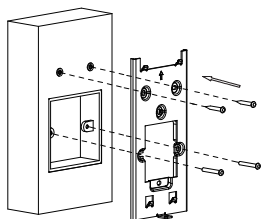

Fix the wall-mounting bracket with two M4x30 screws and two ST4x20 screws.

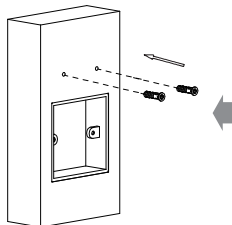

Insert two plastic wall anchors into the two drilled holes.

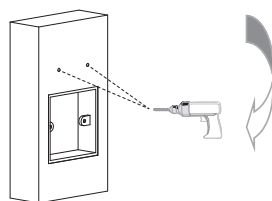

Use a hand drill with 5 mm diameter bit to make two positioning holes with 25 mm in depth in the marked positions.

1.1.2 With 2x3 inches embedded single-gang box in the Wall

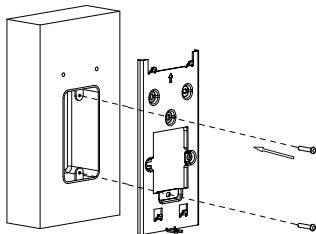

Fix the wall-mounting bracket on the single-gang junction box with the two M4x30 screws.

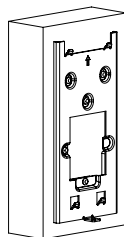

Finish the bracket installation.

1.2 Without embedded gang box in the wall

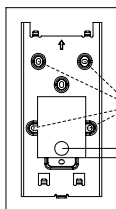

According to the position of the cable, put the wall-mounting bracket closely on to the wall and mark the four positioning holes, while making sure that relative positions between wall-mounting bracket and wire hole are correct.
 Note: The positioning holes should be marked in the center of the holes.

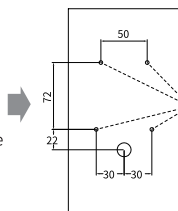

Take off the wall-mounting and drill the four marked positioning holes and the wire holes using 5 mm hand drills.

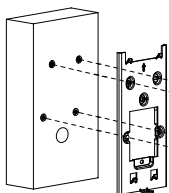

Fix the wall-mounting bracket with four ST4x20 screws.

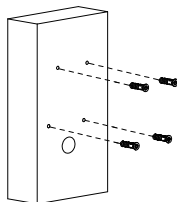

Insert four plastic wall anchors into the holes.

2. Step 2: Device Installation

2.1 Device Installation without Digital Forehead or Wrist Temperature Detector

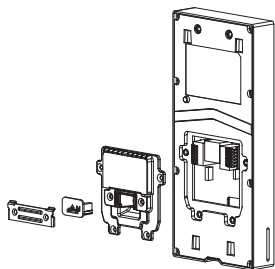

Take out the device along with the back cover, cable locking plate, rubber plug and corresponding screws.

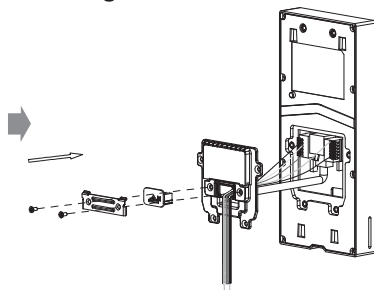

Lead the wires from the wall-mount bracket and the detector through the square hole on the back cover, connecting them to the corresponding interface of the main board.
 Select a suitable size rubber plug to push all the cables into the back cover. Fix cable locking plate to the back cover with two M2.5x6 screws.

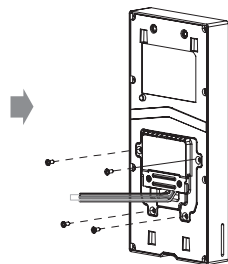

Fasten the back cover with four Torx screws using the Torx wrench attached.

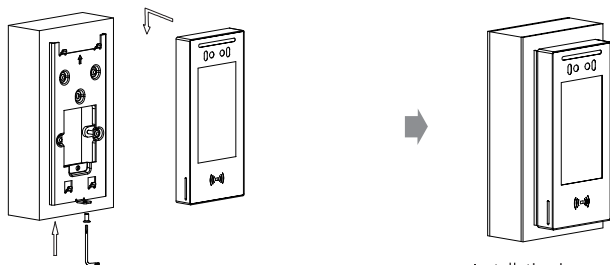

Hang the device on to the square hanger on the wall mounting bracket, pull down the device to make it fall completely on to the square hanger on the wall-mounting bracket, then use the Torx Wrench attached to tighten the device with the Torx screw.

Installation is completed.

2.2 Device Installation with Digital Forehead Temperature Detector (Optional)

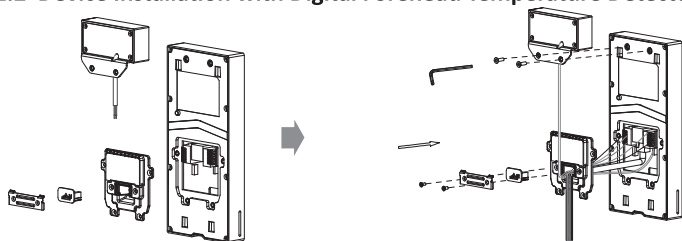

Take out the door phone and the digital forehead temperature detector and then take out back cover, cable locking plate, and rubber plug.

Fasten the detector on to the nuts on the device's rear cover with two M3X10.5 screws using the Allen wrench attached, and lead the wires from the wall-mount bracket and the detector through the square hole on the back cover, connecting them to the corresponding interface of the main board. And then select a suitable size rubber plug to push all the cables into the back cover. Fix the cable locking plate to the back cover with two M2.5x6 screws.

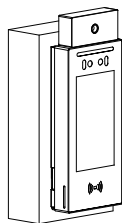

Installation is completed.

Hang the device on to the square hanger on the wall mounting bracket, pull down the device to make it fall completely on to the square hanger on the wall-mounting bracket, then use the Torx Wrench attached with to tighten the device with the Torx screw.

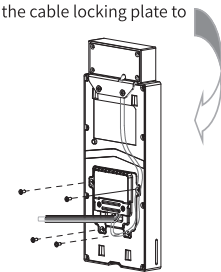

Fasten the back cover with four Torx screws using the Torx wrench attached.

2.3 Device Installation with Digital Wrist Temperature Detector (Optional)

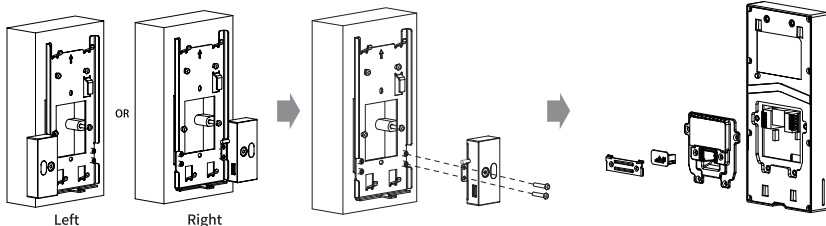

Fix the two holes of the detector onto the installation pins on the wall-bracket either on the left or right according to your preference.

Tighten the detector on to the inner threaded bolt with two M3x6 screw using the Allen wrench attached in the same way on both side.

Take out the device along with the back cover, cable locking plate, rubber plug, and corresponding screws.

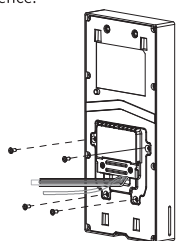

Fasten the back cover with four Torx screws using the Torx wrench attached.

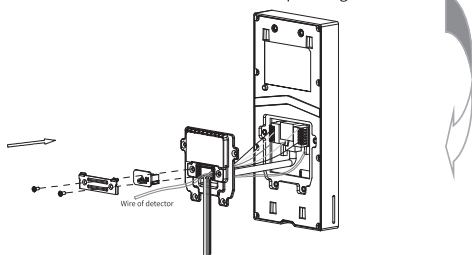

Lead the wires from the wall-mount bracket and the detector through the square hole on the back cover, connecting them to the corresponding interface of the main board. And then select a suitable size rubber plug to push all the cables into the back cover. Fix cable locking plate to the back cover with two M2.5x6 screws.

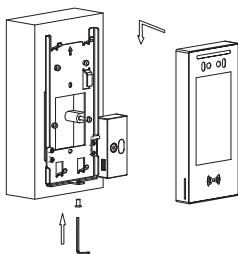

Hang the device on to the square hanger on the wall mounting bracket, pull down the device to make it fall completely on to the square hanger on the wall-mounting bracket, then use the Torx wrench attached to tighten the device with the Torx screws.

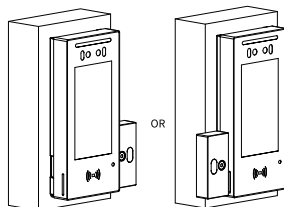

Installation is completed.

Device Wiring

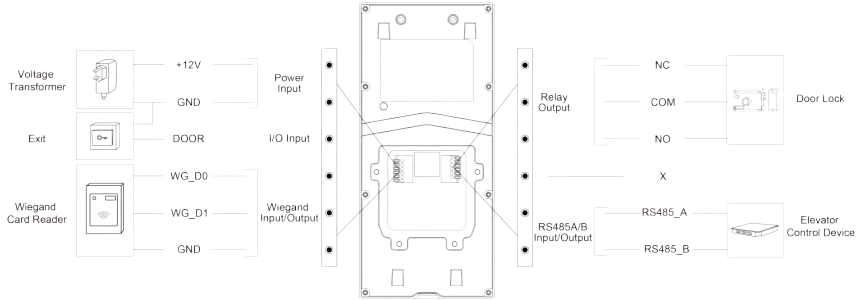

Application Network Topology

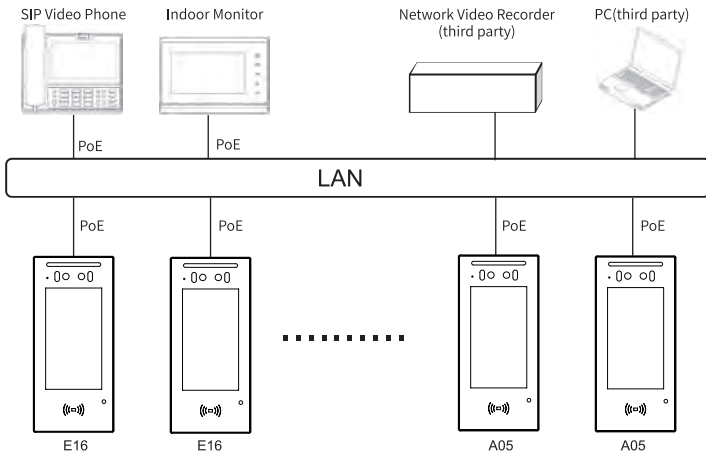

Configuration

- 1.IP address Checking:** Long press any where on the initial screen for approximately five minutes to go to project PIN screen where you enter the default PIN “admin” and press **Confirm** tab to go to Setting screen where you press **Info** icon to check for the device IP address. (for E16 series door phone only)
- 2.Account Registration:**On the web interface, go to the path **Account -> Basic** page to register and fill in the account information. (please refer to user manual for more information)
- 3.DTMF code configuration:** On the web interface, go the path: **Access Control->relay** to set up the DTMF code in the corresponding area.

Operation

Make a call:

Enter the IP or SIP number and press Dial key to make a call

Receive a call:

E16/A05 supports Auto Answer by default. Incoming call from indoor device will be answered automatically.

Unlock by DTMF:

During the call, press the corresponding DTMF code from the answer unit to unlock E16/A05 remotely.

Unlock by RF Card:

Place the predefined RF card in the RF reader area to open the door.

Notice Information

Akuvox E16/A05 firmware contains third-party open source software under the terms of the GNU General Public License(GPL). Akuvox is committed to meeting the requirements of the GNU General Public License (GPL) and will make all required source code available.

The source code of software under the terms of GNU GPL can be downloaded online: <http://www.akuvox.com/gpl>.

Information contained in this document is believed to be accurate and reliable at the time of printing. This document is subject to change without notice, any update to this document can be viewed on Akuvox' s website: <http://www.akuvox.com> © Copyright 2020 Akuvox Ltd. All rights reserved.



AKUVOX (XIAMEN) NETWORKS CO., LTD.

ADD: 10/F, NO.56 GUANRI ROAD, SOFTWARE PARK II, XIAMEN 361009, CHINA
www.akuvox.com



YS15000009